

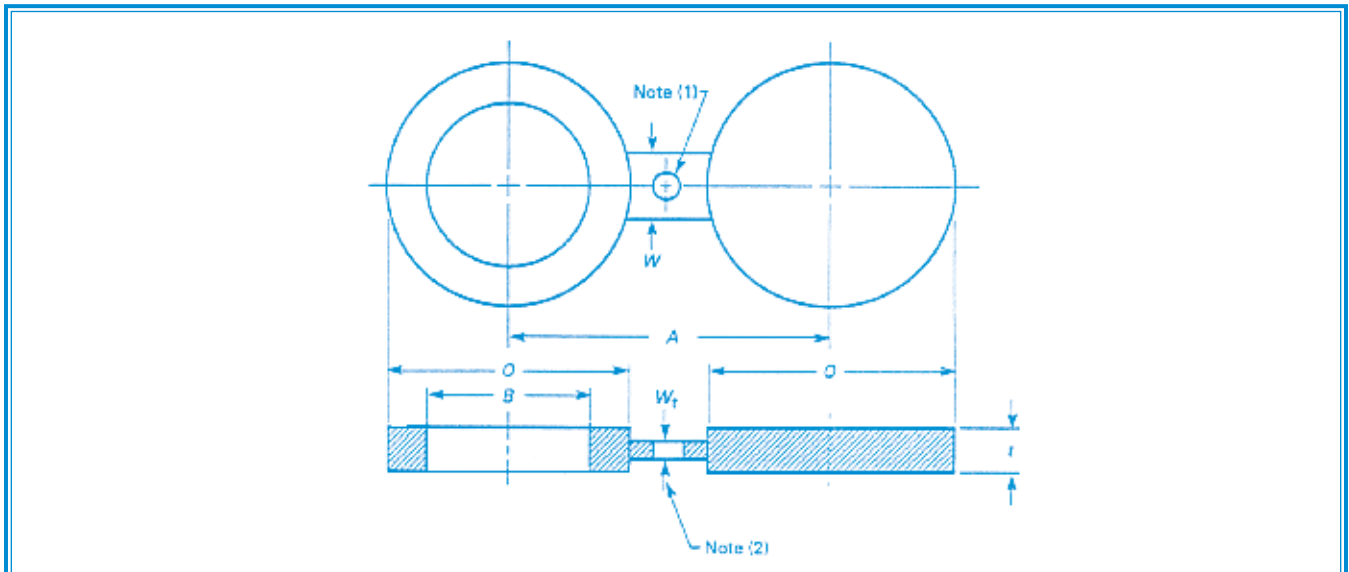

PRODUCT SPECIFICATIONS

Spectacle (Figure 8) Blinds

Dimensions Are In Inches - Weights Are In Pounds



CLASS 900

NPS	Inside Diameter B , In.	Outside Diameter O , In.	Centerline Dimension A , In.	Thickness t , In.	Web Width W , In.
1/2	0.62	2.38	3.25	0.25	1.50
3/4	0.82	2.62	3.50	0.25	1.62
1	1.05	3.00	4.00	0.25	2.25
1 1/4	1.44	3.38	4.38	0.38	2.25
1 1/2	1.68	3.75	4.88	0.38	2.62
2	2.16	5.50	6.50	0.50	2.25
2 1/2	2.64	6.38	7.50	0.50	2.62
3	3.26	6.50	7.50	0.62	2.62
4	4.26	8.00	9.25	0.75	3.00
5	5.30	9.62	11.00	0.88	3.38
6	6.36	11.25	12.50	1.00	3.38
8	8.33	14.00	15.50	1.38	3.75
10	10.42	17.00	18.50	1.62	4.12
12	12.39	19.50	21.00	1.88	4.12
14	13.62	20.38	22.00	2.12	4.50
16	15.62	22.50	24.25	2.38	4.88
18	17.62	25.00	27.00	2.62	5.25
20	19.56	27.38	29.50	2.88	5.25
24	23.50	32.88	35.50	3.50	6.00

NOTES:

- (1) Hole size (where required due to bolt spacing) shall be the same as the flange bolt hole, and located such that it will not interfere with bolting between two flanges.
- (2) The thickness of the tie bar dimension W_t shall be 0.25 in. minimum, except when t is less than 0.25 in., W_t shall equal t .